

EXAflow[®]

TUNNEL GATE INSERTS
THE INTELLIGENT SOLUTION
MAXIMUM OPERATING EFFICIENCY

GATE INSERT OPTIONS

Standard Flow Round GTR Series

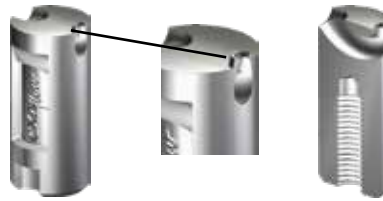

Page 3

Standard Flow Rectangular GTE Series

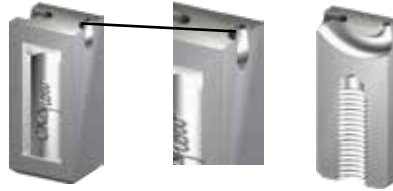

Page 4

Closed Gate Miniflow[®] GTM Series



Page 5

Conturable Gate Midiflow[®] GTK Series



Page 6

Conturable Gate Maxiflow[®] GXK Series



Page 7

Conturable Gate Konturflow[®] GTK Series



Page 8

Conturable Gate Ringelflow[®] GRF Series

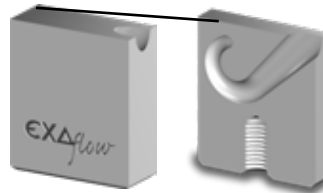

Page 9

Anti-Rotational Locking System, Viscosity Tables & Installation Dimensions

Page 10-11

Service:

Need help choosing the correct cashew gate? DME engineers are available to assist with a free consultation to identify the ideal cashew gate for your application.

Please send the following information to: DME_Mech_Eng@dme.net

- A copy of your expanded model in XT or Step format
- Resin type
- Gate location
- Number of cavities

We will send you back your model with the cashew gate installed within 24 hours.

STANDARD FLOW GTR SERIES

For tunnel gating of small to medium sized moldings along a flat separating plane. The projecting calotte ensures concealed degating.

- Available gate diameters from 0.8 to 2.4mm
- Usable for all thermoplastics including fillers up to 50% glass fiber.

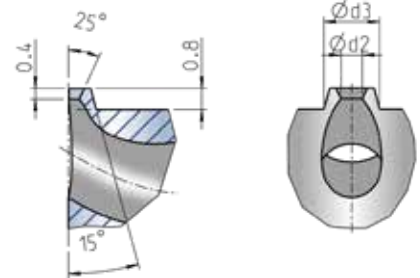
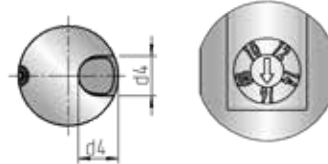
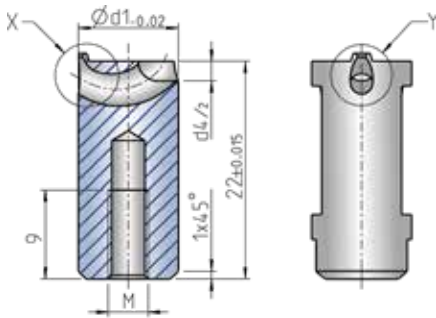

ITEM NUMBER	d1	d2	d3	d4	M	VISCOSITY (RHEOLOGY)		
						HIGH FLOWABILITY	REGULAR FLOWABILITY	POOR FLOWABILITY
GTR1008	10	0.8	2.1	4	4	8	7	5
GTR1012		1.2	2.5			20	16	10
GTR1014		1.4	2.7			30	23	15
GTR1016		1.6	2.9			40	30	20
GTR1208	12	0.8	2.1	5	5	8	7	5
GTR1210		1	2.3			14	12	9
GTR1212		1.2	2.5			20	16	10
GTR1214		1.4	2.7			30	23	15
GTR1216		1.6	2.9			40	30	20
GTR1218		1.8	3.1			54	40	27
GTR1220		2	3.3			68	52	34
GTR1412	14	1.2	2.5	6	6	20	16	10
GTR1414		1.4	2.7			30	23	15
GTR1416		1.6	2.9			40	30	20
GTR1418		1.8	3.1			54	40	27
GTR1420		2	3.3			68	52	34
GTR1422		2.2	3.5			85	65	43
GTR1424		2.4	3.7			100	80	50

WEIGHT IN GRAMS

INSTALLATION EXAMPLE

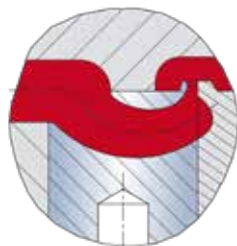
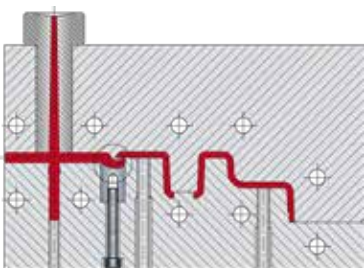

Additional Information:

Page 10 - Anti-rotation locking system & Viscosity table
 Page 11 - Installation dimensions

STANDARD FLOW GTE SERIES

For tunnel gating of small to medium sized moldings along a flat separating plane. The projecting calotte ensures concealed degating.

- Available gate diameters from 0.8 to 2.4mm
- Usable for all thermoplastics including fillers up to 50% glass fiber.

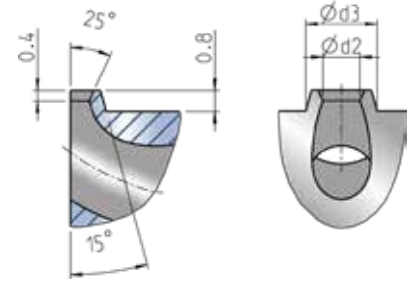
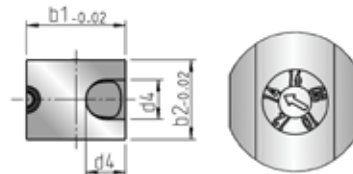
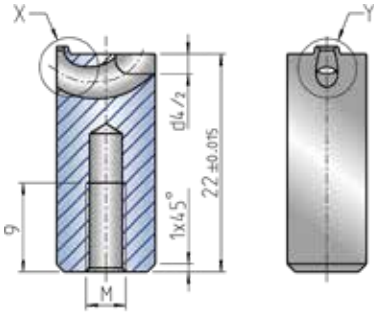

ITEM NUMBER	b1	b2	d2	d3	d4	M	VISCOSITY (RHEOLOGY)		
							HIGH FLOWABILITY	REGULAR FLOWABILITY	POOR FLOWABILITY
GTE1008	10	8	0.8	2.1	4	4	8	7	5
GTE1010			1	2.3			14	12	9
GTE1012			1.2	2.5			20	16	10
GTE1014			1.4	2.7			30	23	15
GTE1016			1.6	2.9			40	30	20
GTE1208	12	10	0.8	2.1	5	5	8	7	5
GTE1210			1	2.3			14	12	9
GTE1212			1.2	2.5			20	16	10
GTE1214			1.4	2.7			30	23	15
GTE1216			1.6	2.9			40	30	20
GTE1218			1.8	3.1			54	40	27
GTE1220			2	3.3			68	52	34
GTE1412	14	12	1.2	2.5	6	6	20	16	10
GTE1414			1.4	2.7			30	23	15
GTE1416			1.6	2.9			40	30	20
GTE1418			1.8	3.1			54	40	27
GTE1420			2	3.3			68	52	34
GTE1422			2.2	3.5			85	65	43
GTE1424			2.4	3.7			100	80	50

WEIGHT IN GRAMS

INSTALLATION EXAMPLE

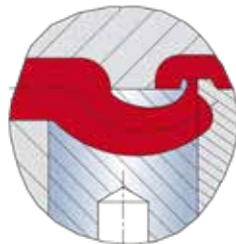
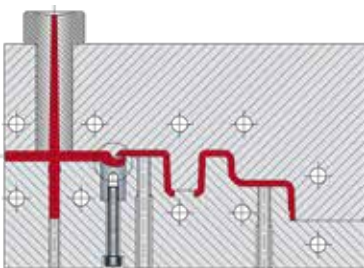

Additional Information:
 Page 10 - Viscosity table
 Page 11 - Installation dimensions

CLOSED GATE MINIFLOW® GTM SERIES

Designed for tunnel gating of small, thin-walled moldings. This gate insert has a closed gate diameter and is therefore suitable for the use of low article weight and for very thin-walled moldings.

- The closed surface enables the creation of individual gate diameters
- Usable for all thermoplastics including fillers up to 50% glass fiber.

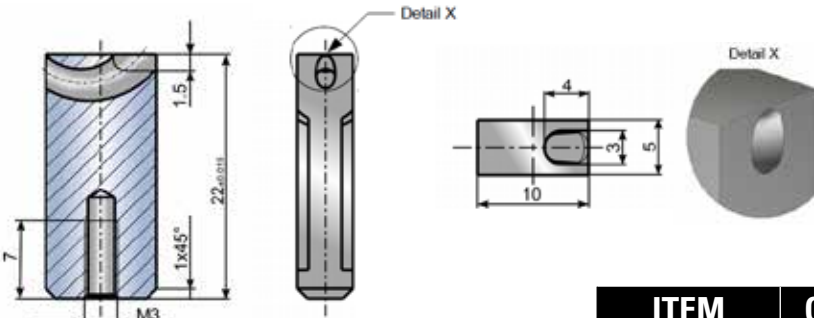

MAX SHOT WEIGHT (GRAMS)

ITEM NUMBER	GATE Ø (mm)	MAX SHOT WEIGHT (GRAMS)		
		HIGH	MEDIUM	LOW
GTM1011	1.1	17	14	9

Miniflow GTM (without gate) recommended procedure to insert the gate.

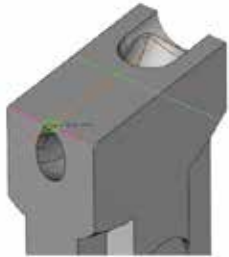

1. Create the gate in 3D CAD. Draw a circle on the end face with the diameter or radius of the gate. Above shows a radius R0.8 in green.



2. Extrude this sketch with max. possible angle of inclination, depending on gate size, or remove the material immediately by cutting the material incl. draft/taper angle.



3. Well round off the sharp edge between the bent tunnel and the gate, e.g. by hand using a diamond mounted point.



4. Around the gate you can adjust the GTM Miniflow to the contour and leave a calotte standing, as shown above.

INSTALLATION EXAMPLE

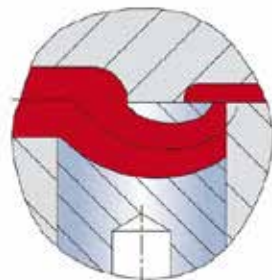
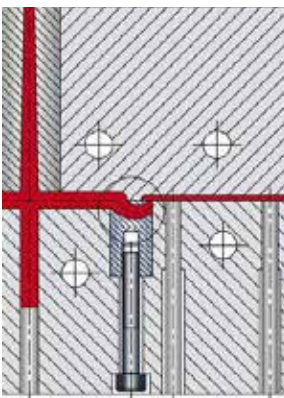

Additional Information:
 Page 10 - Viscosity table
 Page 11 - Installation dimensions

CONTOURABLE MIDIFLOW® GMK SERIES

For bottom (submarine) gating of medium components. Supports contouring to a depth of 8 mm. Suitable for gate diameters up to 1.8mm, shot weights up to 200g per insert and all common plastics, including reinforced type.

- Permits gating immediately behind projecting ribs
- Gate may be remote from molding wall
- The spherical geometry in the gate area permits gating on inclined or curved surfaces



ITEM NUMBER
GMK1

Gating point may be located up to 8mm above the parting line

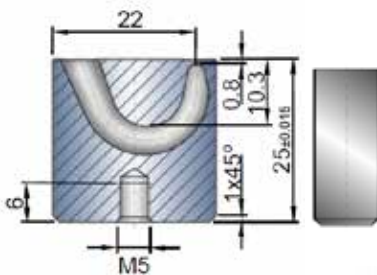

ITEM NUMBER
GMK2

Gating point may be located up to 5mm above the parting line

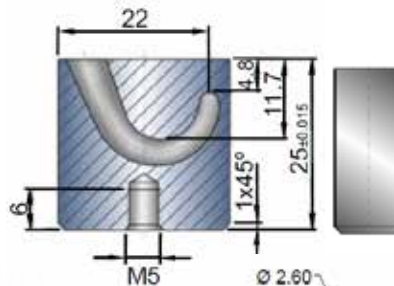

ITEM NUMBER
GMK3

Gating point may be located up to 8mm above the parting line

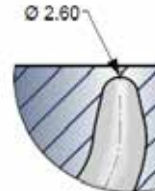
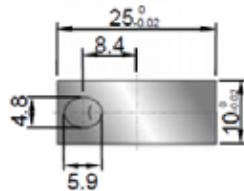
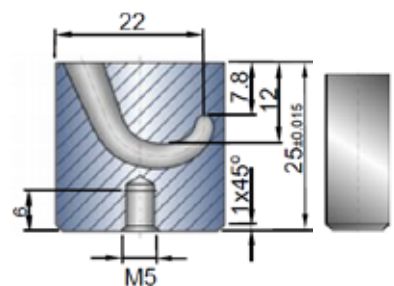

The spherical geometry in the gate area permits gating on incline or curved surfaces.

Additional Information:
Page 10 - Viscosity table
Page 11 - Installation dimensions

INSTALLATION EXAMPLES

BELOW PARTING LINE



GMK1

ABOVE PARTING LINE



GMK2



GMK3



CONTOURABLE MAXIFLOW® G XK SERIES

For bottom (submarine) gating of medium components. Supports contouring to a depth of 10 mm. Suitable for gate diameters up to 3.5mm, shot weights up to 1200g per insert and all common plastics, including reinforced type.

- Permits gating immediately behind projecting ribs
- Gate may be remote from molding wall
- The spherical geometry in the gate area permits gating on inclined or curved surfaces

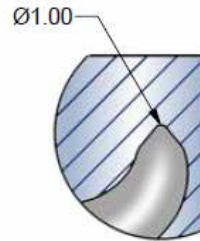
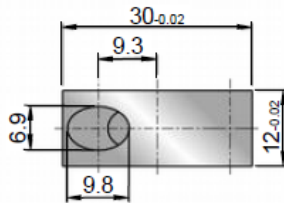
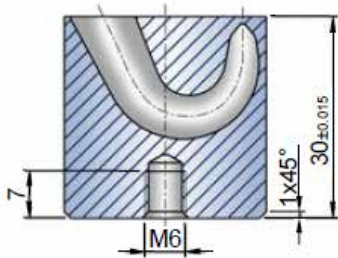
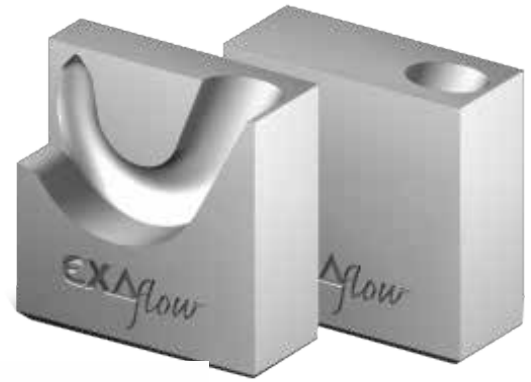

The spherical geometry in the gate area permits gating on incline or curved surfaces.

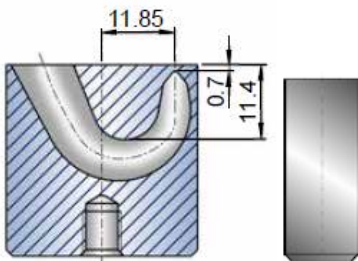

ITEM NUMBER

GXX1

Gating point may be located up to 10mm above the parting line

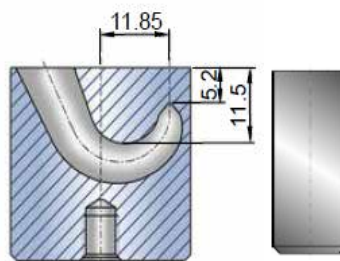
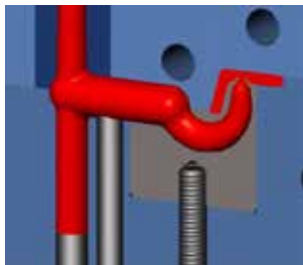

ITEM NUMBER

GXX2

Gating point may be located up to 5mm above the parting line

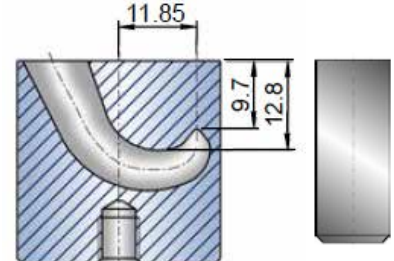
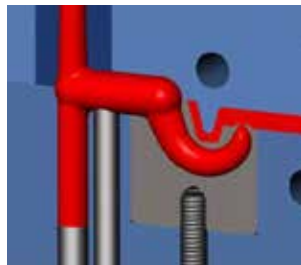

ITEM NUMBER

GXX3

Gating point may be located up to 10mm above the parting line

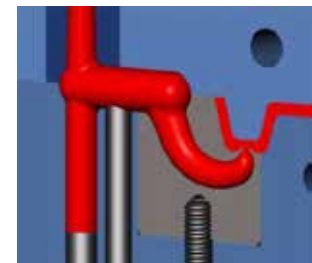

For best operating results the Maxiflow® insert requires one central ejector and one supporting ejector. Please ensure that all sharp edges in the runner are thoroughly rounded. For reliable demolding, the diameter of the runner must exceed that of the curved tunnel.

Contouring of a supporting ejector



Optimum gate geometry, with edges rounded

Additional Information:
Page 10 - Viscosity table
Page 11 - Installation dimensions

CONTOURABLE KONTURFLOW® GTK SERIES

For tunnel gating of small to medium sized components contoured in the gate area.

- Maximum gate diameter (pointed tunnel) up to 1.7mm
- Contourable up to 3mm depth
- Usable for all thermoplastics including fillers up to 50% glass fiber

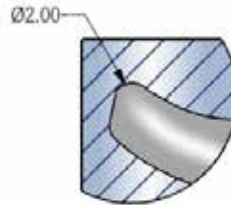
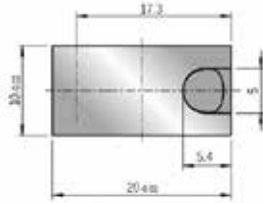
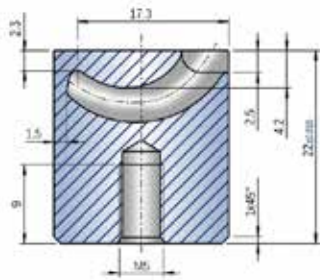

The spherical geometry in the gate area permits gating on incline or curved surfaces

ITEM NUMBER
GTK

GMK, GTK & GXK CALOTTE DESIGNS

STANDARD

Contourable insert in unfinished state

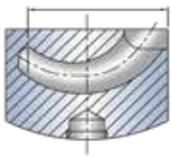

Diameter to be defined in accordance with the table

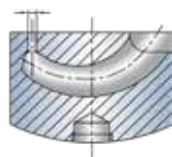

Define 60 to 90° angle at bore / tunnel intersection point

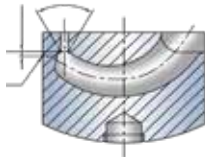

Calotte wall thickness to be between 0.5 and 0.7mm

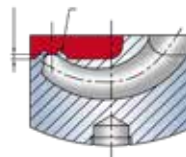

Provide radius if possible

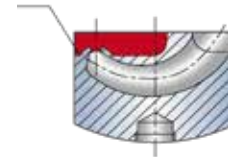

Finish calotte drawing

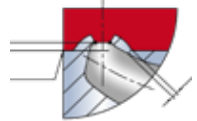

Calotte on molded product



INCLINED SURFACE

Contourable insert in unfinished state

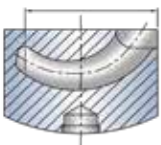

Diameter to be defined in accordance with the table

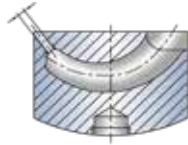

Define 60 to 90° angle at bore / tunnel intersection point

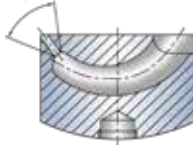

Calotte wall thickness to be between 0.5 and 0.7mm

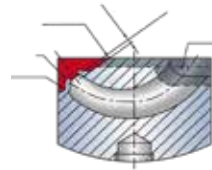

Provide radius if possible



Calotte on molded product



CURVED SURFACE

Contourable insert in unfinished state

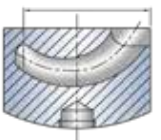

Diameter to be defined in accordance with the table

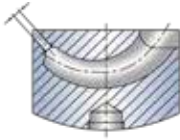

Define 60 to 90° angle at bore / tunnel intersection point

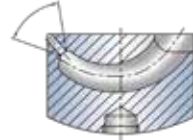

Calotte wall thickness to be between 0.5 and 0.7mm

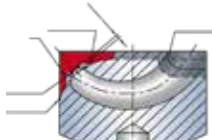

Provide radius if possible



Calotte on molded product



CONTOURABLE RINGEFLOW® GRF SERIES

For rear gating of small to medium size components. Optimum solution to prevent jetting and leaves no gate marks on visible external surface and bottom wall. Ideal for fully rounded edges and permits internal gating of 2 component moldings.

- Maximum gate diameter (pointed tunnel) up to 1.8mm
- Contourable up to 3mm depth
- Usable for all thermoplastics including fillers up to 50% glass fiber

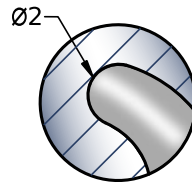
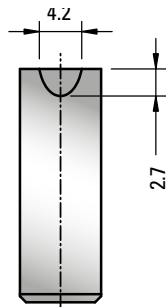
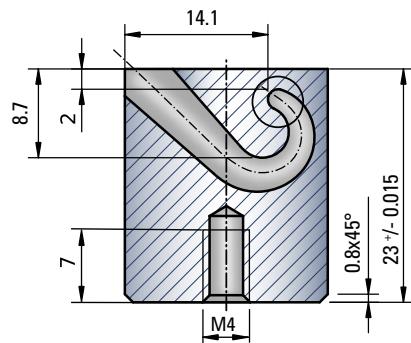

The spherical geometry in the gate area permits gating on incline or curved surfaces

ITEM NUMBER

GRF-5

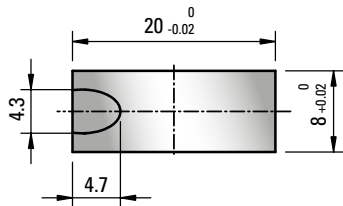

INSTALLATION EXAMPLE

For best operating results the Ringeflow® insert requires one central ejector and one supporting ejector. Please ensure that all sharp edges in the runner are thoroughly rounded. For reliable demolding, the diameter of the runner must exceed that of the curved tunnel.

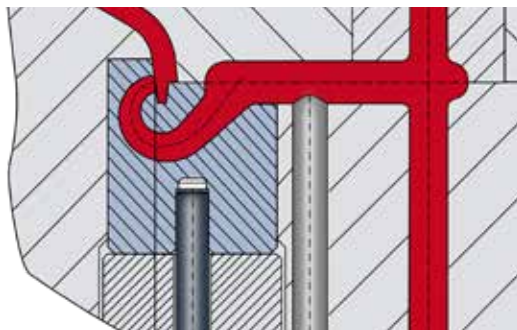

Contouring of a supporting ejector



Optimum gate geometry, with edges rounded

ANTI-ROTATION LOCKING SYSTEM

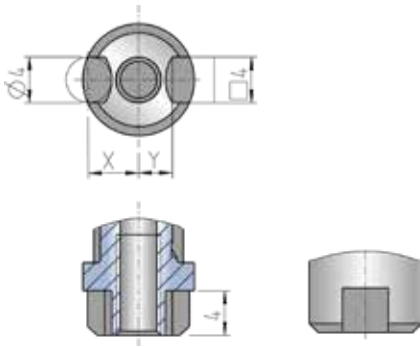



ANTI-ROTATIONAL LOCKING SYSTEM DIMENSIONS		
ITEM NUMBER	PARALLEL PIN DISTANCE X	KEY DISTANCE Y
GTR10	4.5mm	3.0mm
GTR12	5.2mm	3.8mm
GTR14	6.0mm	4.5mm

The insert can be secured against inadvertent rotation by a parallel pin and key system. In most cases the gate insert is adequately secured by the bolt.

TABLE OF VISCOSITY - STANDARD TUNNEL GATES

- 

LOW VISCOSITY
(PA, PE, PC, PET, PVC, PS, SB, TPA, TPE, TPU)
- 

MEDIUM VISCOSITY
(ASB, ASA, PS, PC/ABS, PBT, SAN)
- 

HIGH VISCOSITY
(PC, PPS, PSU, POM-H, PES, PPO, PEI, PC-ABS, PC-PBT, PMMA, PVC)

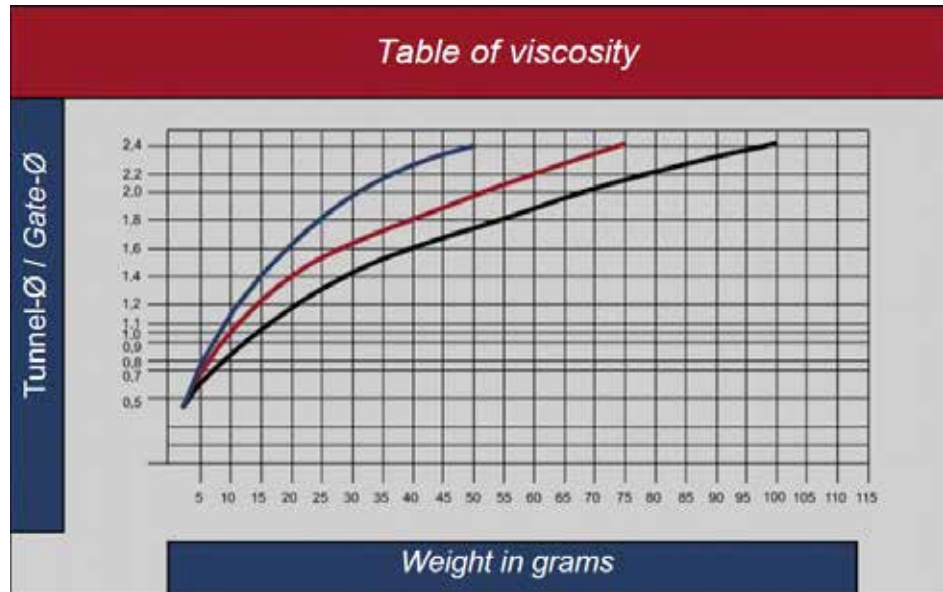
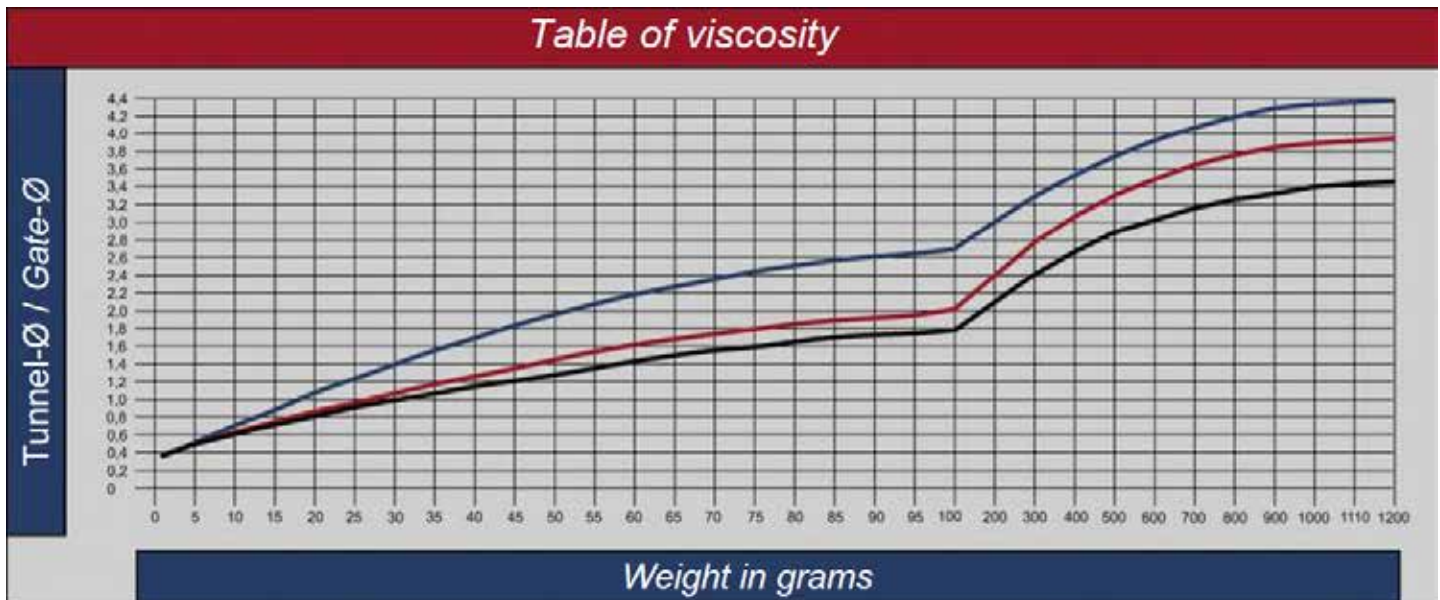
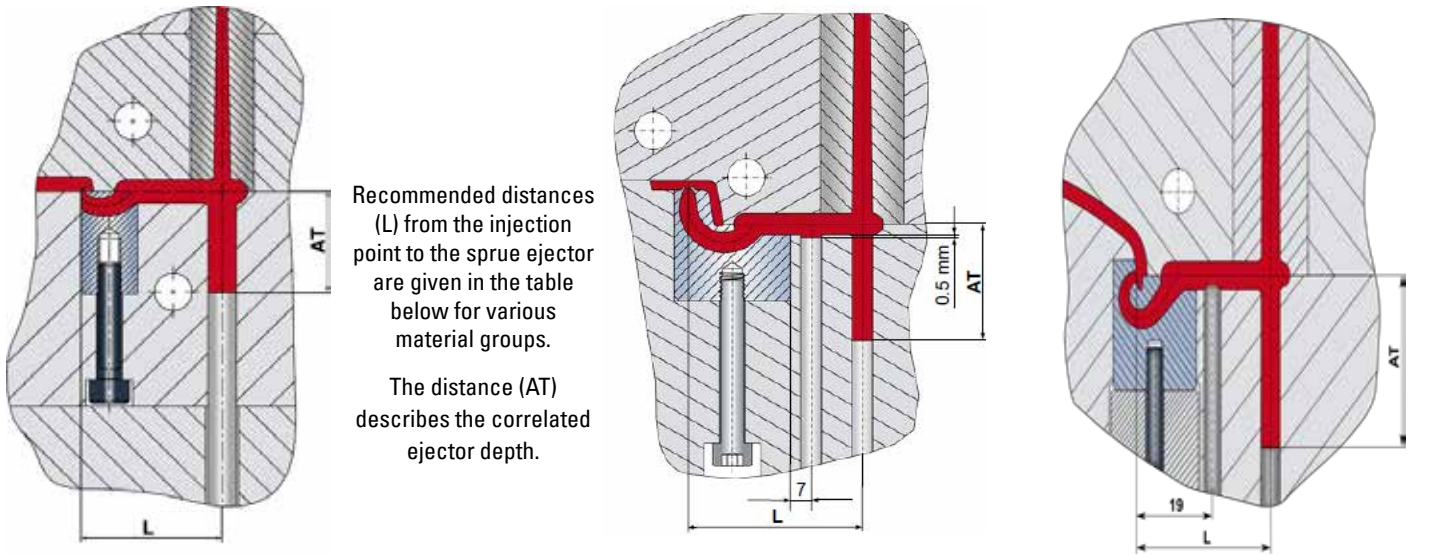
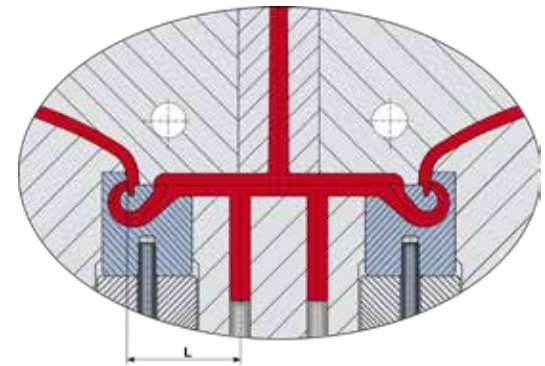
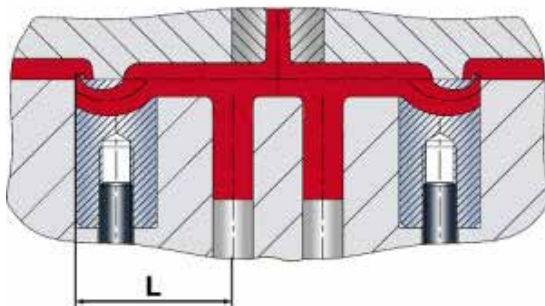

TABLE OF VISCOSITY - CONTOURABLE INSERTS



INSTALLATION DIMENSIONS GTR/GTE, GTM, GMK, GRF

GRF-Series

PLASTIC GROUP	GTR/GTE	GTM	GTK	GXK	GMK	GRF
HD-PE, LD-PE, PET, PP, PA, PC, PVC. (L)	>20	>15	>25	>35	>25	>35
RUNNER DESIGN	ROUND					
EJECTOR DEPTH (AT)	>16	>11	>20	>35	>20	>35
ABS, M ABS, ASA, PS, PC/ABS, POM, PBT. (L)	>25	>20	>30	>40	>30	>40
RUNNER DESIGN	ROUND					
EJECTOR DEPTH (AT)	>20	>14	>24	>40	>24	>40
ELASTOMER TPE, TPU, TPP, TPA.(L)	>15	>15	>20	>30	>20	>30
RUNNER DESIGN	ARBITRARY					
EJECTOR DEPTH (AT)	>11	>11	>16	>30	>16	>35
BRITTLE PLASTICS (L)	>30	>25	>40	UPON REQUEST		
RUNNER DESIGN	HALF-ROUND					
EJECTOR DEPTH (AT)	>24	>18	>32	UPON REQUEST		

With tens of thousands of products to choose from, DME is your one-stop shop for everything molding.

From complex undercuts solutions and plate control to standard pins, bushings and interlocks, the DME line of mold components will help you build or rebuild your mold base inside out, top to bottom. Industrial Supplies, Mold Bases, MUD Quick-Change, Control Systems, and Hot Runner solutions round out our extensive offering to truly be your one-stop shop.



World Headquarters

DME Company LLC

29111 Stephenson Highway

Madison Heights, MI 48071

800-626-6653 toll-free tel

248-398-6000 tel

888-808-4363 toll-free fax

www.DME.net web

DME@DME.net e-mail

DME of Canada Ltd.

5345 Outer Drive Unit# 3

Windsor, Ontario

Canada N9G 0C4

800-387-6600 toll-free tel

905-677-6370 tel

800-461-9965 toll-free fax

DME_Canada@dme.net e-mail

DME Mexico / South America

Circuito el Marques Notre, No.55

Parque Industrial El Marqués

El Marqués, Querétaro, CP 76246

52.442.713.5666 tel

DME_Mexico@DME.net

